



# Dri-Eaz® Dehumidifier Command Hub Installation Special Instructions for 2800i and 3500i Models

Legend Brands, Inc.

15180 Josh Wilson Road, Burlington, WA 98233

Phone: 800-932-3030 Fax: 360-757-7950 [LegendBrandsRestoration.com](http://LegendBrandsRestoration.com)

**Below are the steps required to install the Command Hub in 2800i and 3500i dehumidifiers.**

Find these instructions and more information on the Command Hub at [DehuCommandHub.LegendBrandsRestoration.com](http://DehuCommandHub.LegendBrandsRestoration.com)

## Step 1

**Unplug or disconnect power to the dehumidifier.**

Using a #2 Philips screwdriver, remove the 4 mounting screws – set aside and save to secure the Command Hub.

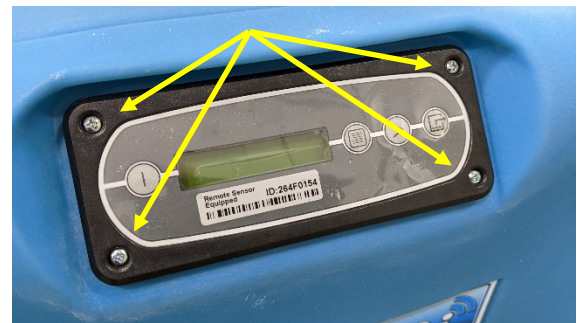

## Step 2

Lift out the old i-Series controller and remove the 4 cables from the back – 2 temp sensors and 1 data cable.



**NOTICE:** Certain older models may include a pair of red and black wires with spade connectors located inside the housing behind the control panel. These wires are not used with the Command Hub installation and should be tucked back inside the housing.

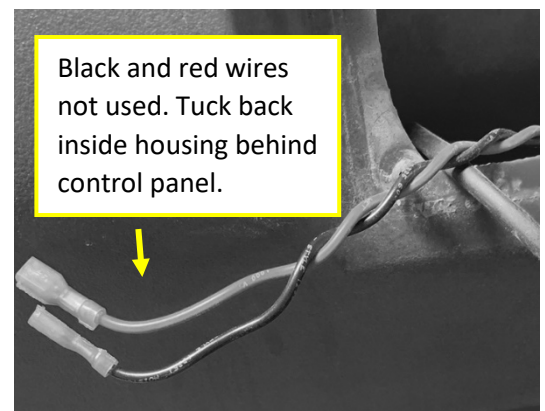

### Step 2a

Use a 1/16" drill bit to drill a pilot hole roughly 1/4" above the air inlet hole (see photo). **IMPORTANT:** Do not drill more than 1/4" past the plastic to prevent drilling into the filter behind the inlet.

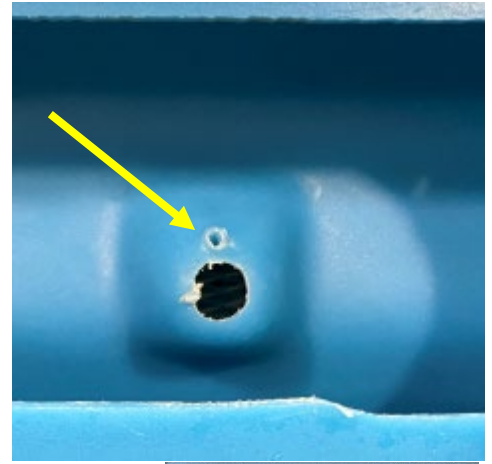

### Step 2b

Remove and discard the plastic stud that is connected to the sensor included with this kit.

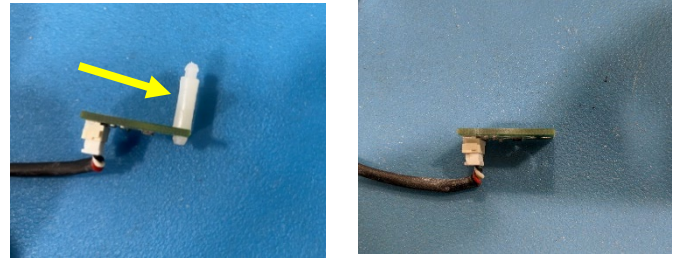

### Step 2c

Using the #4 screw included in the kit, screw the sensor into the pilot hole with the center of the sensor directly over the air inlet. Note: Be sure that the wire connector is facing up, not down.

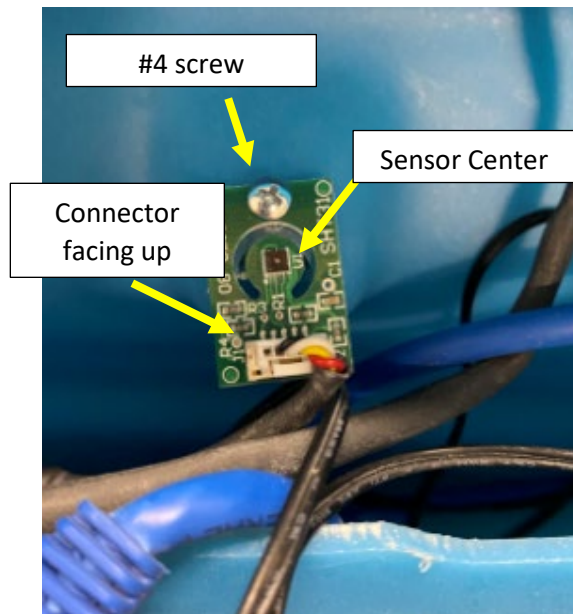

### Step 3

Connect the cables to the Command Hub as shown. Take care not to tangle or twist the cables and ensure the controller is oriented correctly. Connect the four cables to the new controller as follows:

1. Temp/RH connector to K3/RH1 receptacle. K4 receptacle is not used.
2. Blue data cable to K2 socket
3. Defrost temp sensor – silver tab to K5/DEF receptacle
4. Outlet temp sensor to K6/Out receptacle

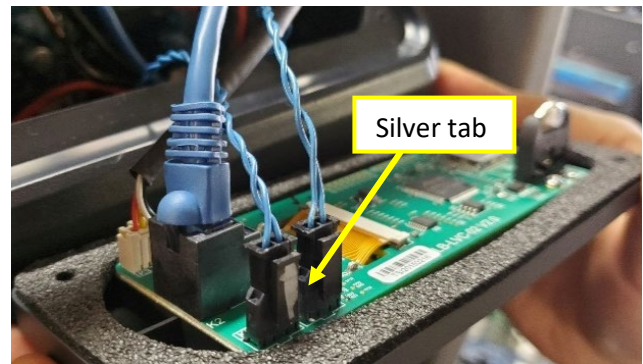

### Step 4

Place the Command Hub into position and, to avoid stripping mounting holes, **hand-tighten** the 4 screws that were removed from the previous i-Series controller in Step 1. Once the controller is secured to the dehumidifier, plug in the unit. The first Config screen will display after a brief start-up cycle. Enter the serial number of the dehumidifier from the serial label on the unit. Six (6) digits are required; if the serial number is less than 6 digits, add zeros (0) in front of the serial number to equal 6 digits. Select OK.

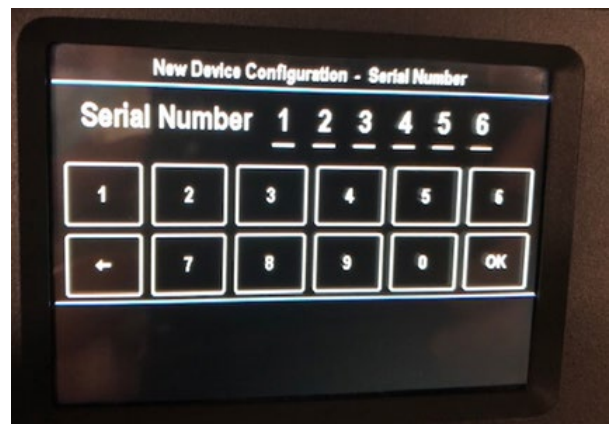

### Step 5

Toggle through the models using the up/down arrow buttons to select the correct dehumidifier model. If you are unsure which dehumidifier model to select, check the product or serial label. Select the right arrow when complete.



## Step 6

Configure the current time clock and date, using the up/down arrows. Select the right arrow when complete.

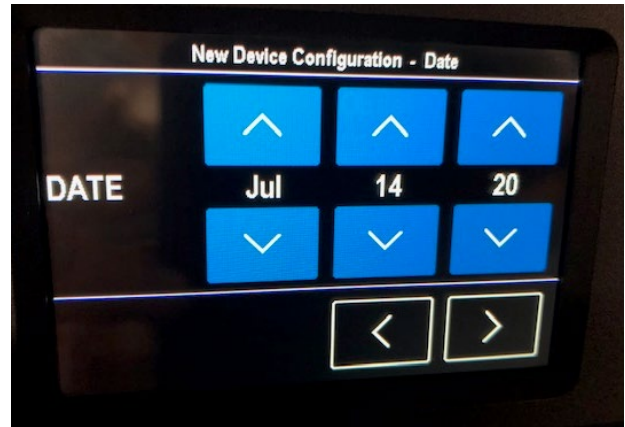

## Step 7

Once you have finished configuring the serial number, model, time, and date, you will see the Home screen in OFF mode. The dehumidifier is ready to be powered on by pressing the Power button:



**When switched ON, the Home screen displays inlet temperature/relative humidity (RH), outlet temp/RH, date, time, Bluetooth connection, and these operation buttons in the lower section: menu, purge and on/off.**

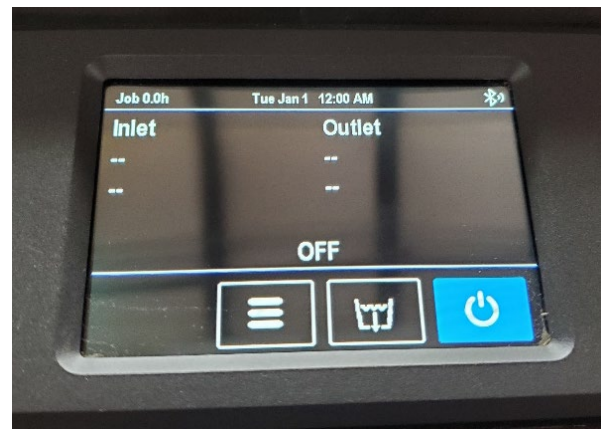

The old controller may now be discarded in a facility that accepts electronic waste.

**The new Command Hub and your dehumidifier are now ready for use.**

**Questions? Please contact Legend Brands Service at [info.legendbrands.com](mailto:info.legendbrands.com) or email [service@legendbrandsrestoration.com](mailto:service@legendbrandsrestoration.com).**